

PART NAME

2 BUTTON GRABBER

PART No.

HH - 3502

REV. DATE

10-29-08

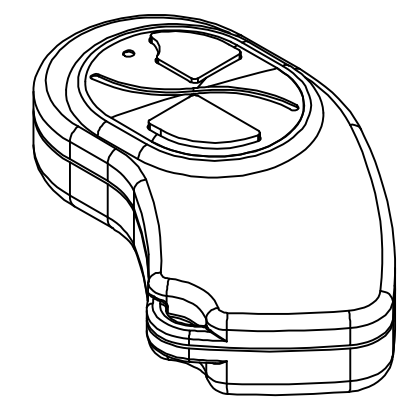
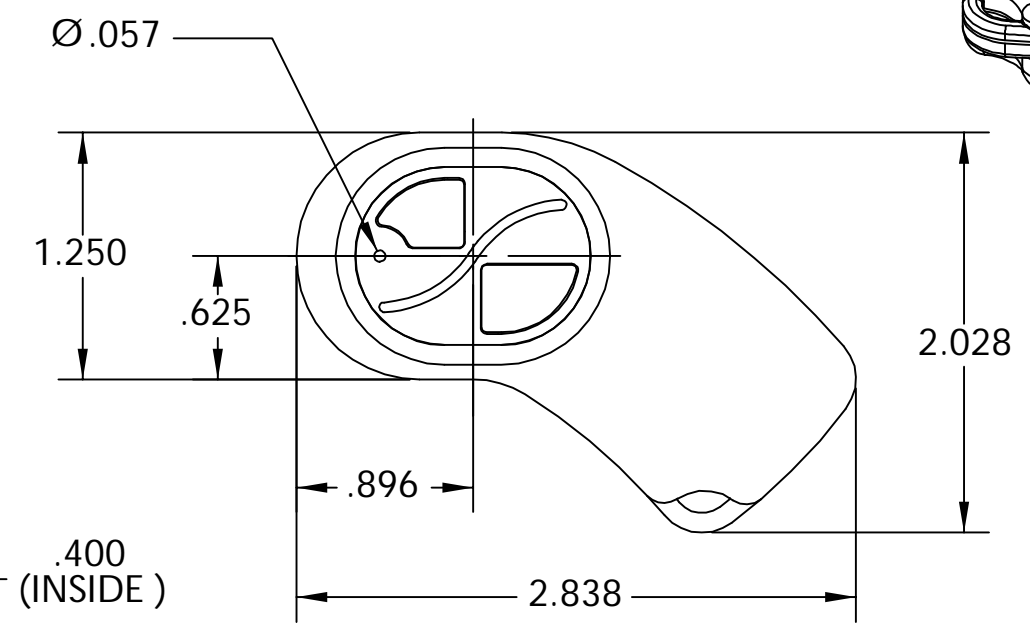
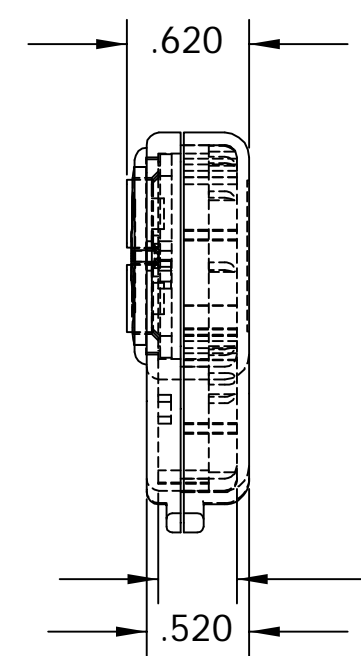
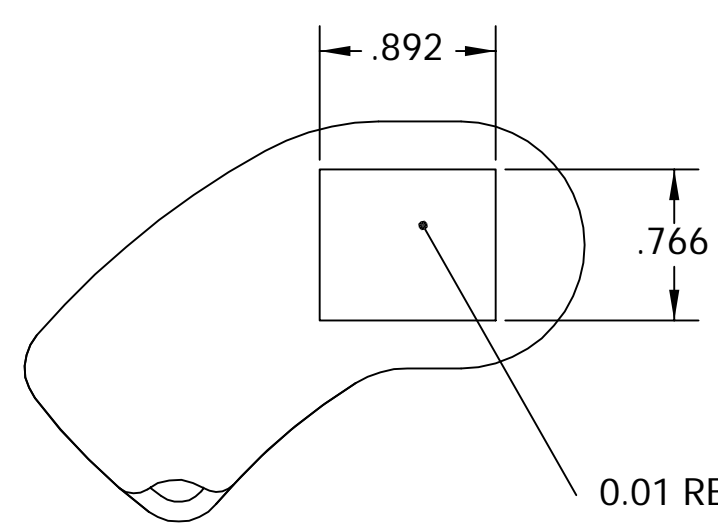

NOTES:

1. ALL DIMENSIONS ARE IN INCHES
2. MATERIAL: BODY & COVER - ABS (UL94-HB)
BUTTON - SILICONE RUBBER
3. FINISH: BODY & COVER - TEXTURED
BUTTON - SMOOTH
4. COLOR: BODY & COVER - BLACK
BUTTON - GRAY
5. PCB IS NOT INCLUDED. TO BE SUPPLIED BY CUSTOMER
6. SUGGESTED BATTERY TYPE: 20 MM COIN CELL TYPE

